



DUKERS
Quality Commercial Refrigeration











BACK BAR COOLER

MODEL DBB72-S3
Sliding Glass Door



PRODUCT FEATURES

-  Equipped with Locking Doors
-  The side mount compressor structure is placed in an easy access area, provides quick and convenient access.
-  R290 Natural Refrigerant promotes faster cool down and efficient energy consumption.
-  Precision digital temperature controls allow pinpoint accuracy with temperatures from 33-38°F.
-  Stainless steel top, sealed interior floors, and rounded cabinet corners for easy cleaning.
-  Adjustable, heavy-duty epoxy coated shelves.
-  Constructed of commercial-grade body panels in black textured finish to fit all decors and living spaces.
-  Featured in a large size and double pane tempered glass block UV light to safely keep all types of drinks ready to serve.
-  LED interior lighting for bright product display.
-  Optional casters with breaks available upon request for better cleaning and mobility.



TECHNICAL SPECIFICATIONS

Voltage/Frequency	115V/60Hz
Refrigerant	R290
Type of Defrost	Automatic
Interior Material	Stainless Steel
Exterior Material	Black Textured Finish
Temperature Range °F	33 ~ 38°F
Compressor Power (HP)	1/3
Nema Config.	NEMA5-15P



HEAVY-DUTY CABINET FRAME & ROBUST DESIGN



DUKERS

Los Angeles | San Francisco | Dallas
Houston | Florida | Chicago | New Jersey

1-800-931-8628

@ info@dukersusa.com

www.DukersUSA.com

DETAILS & SPECIFICATIONS

BACK BAR COOLER

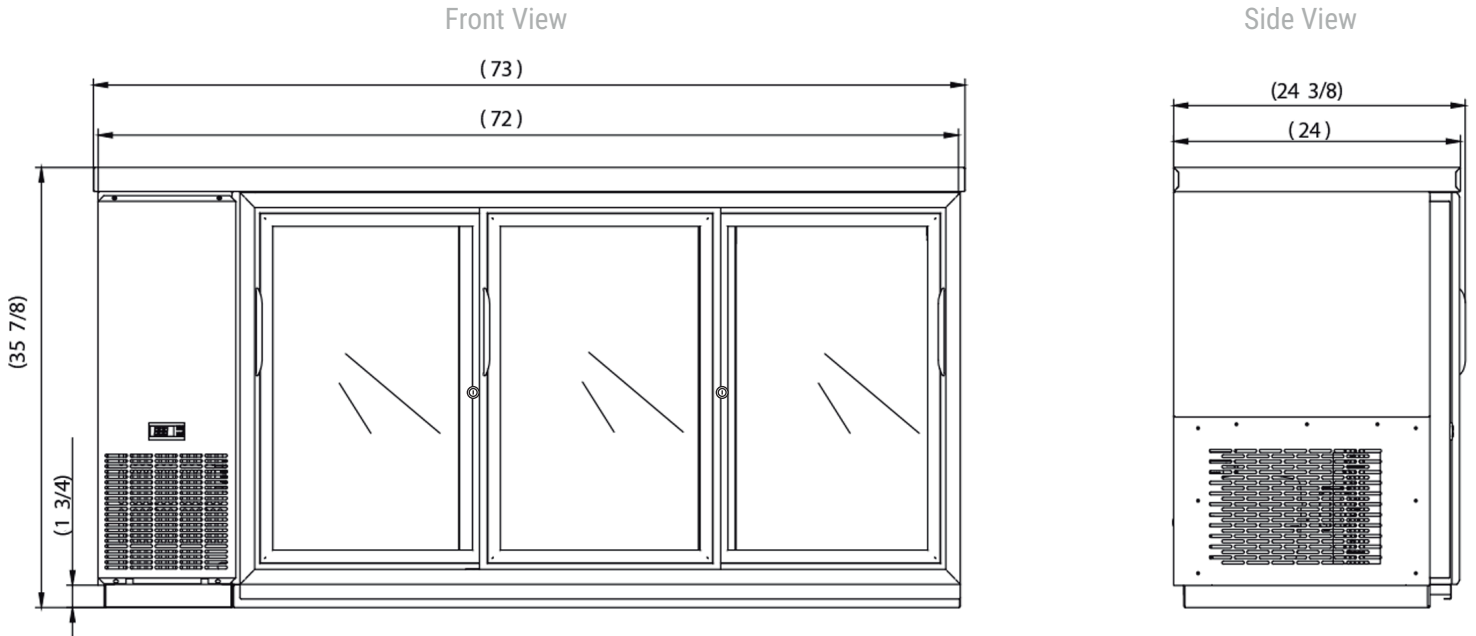

MODEL DBB72-S3

Rated Voltage	115V
Rated Frequency	60Hz
Total Input Power	292W
Total Current	2.76A
Total Capacity	19.2 cu ft
Climatic Category	4-5
Protection Type	I
Design Pressure High Side	385 PSIG
Design Pressure Low Side	150 PSIG
Insulation Blowing Gas	C-Pentane
Refrigerant	R290/3.88 oz



MODEL	EXTERNAL DIMENSION WXDXH (INCHES)	PACKAGING DIMENSION WXDXH (INCHES)	PRODUCT NET WEIGHT	# OF SHELVES	40FT (PCS)
DBB72-S3	73"x24"x35 7/8"	75 3/8"x26 3/8"x43 1/4"	264 lbs	6	36



Los Angeles | San Francisco | Dallas
Houston | Florida | Chicago | New Jersey

1-800-931-8628

@ info@dukersusa.com

www.DukersUSA.com