

# INSTALLATION & OPERATION MANUAL

## Gas Griddle

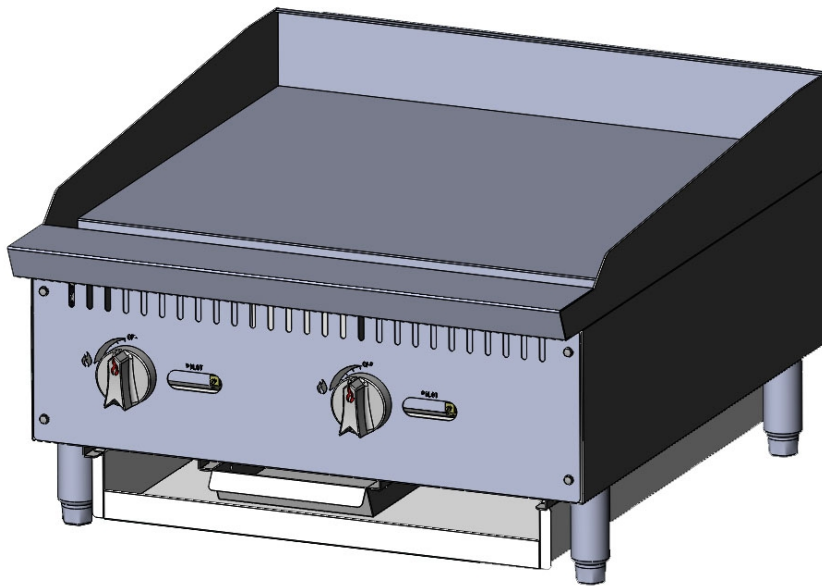

### Models

**DCGMA24**

**DCGMA36**

**DCGMA48**

**DCGM24**

**DCGM36**

**DCGM48**

#### **-IMPORTANT SAFETY NOTICE-**

This manual contains important safety instructions which must be strictly followed when using this equipment. Please retain this manual for future reference.

1-800-931-8628 | [WARRANTY@DUKERSUSA.COM](mailto:WARRANTY@DUKERSUSA.COM) | [WWW.DUKERSUSA.COM](http://WWW.DUKERSUSA.COM)

**FOR YOUR SAFETY**

Do not store or use gasoline or other flammable vapors or liquids in vicinity of this or any other appliance

 **WARNING:** Improper installation, adjustment, alteration, service or maintenance can cause property damage, injury or death. Read the installation, operation and maintenance instructions thoroughly before installing or servicing this equipment.

**INDEX**

**ATTENTION OWENERS AND OPERATORS.....3**

**UNPACKING & INSTALLATION.....4**

**WARNINGS & SAFEGUARDS FOR OPERATION.....7**

**OPERATING INSTRUCTIONGS.....10**

**CLEANING INSTRUCTIONGS.....9**

**LIMITED WARRANTY.....16**

## Attention owner and Operators

The equipment is designed to provide safe and productive processing, cooking and warming of food products as long as the equipment is used in accordance with the instructions in this manual and is properly maintained. Unless the operator is adequately trained and supervised there is a possibility of serious injury. Owners of this equipment bear the responsibility to make certain that this equipment is used properly and safely, and to strictly follow all of the instructions contained in this manual and the requirements of local, state or federal law.

Owners should not permit anyone to touch this equipment unless they are over 18 years old, are adequately trained and supervised, and have read and understood this manual. Do not attempt to repair or convert any gas types on your own. Repairs and conversions are to be made solely by an authorized local servicer.

Owners should also ensure that no customers, visitors or other unauthorized personnel come in contact with this equipment. Please remember that supplier cannot anticipate every circumstance of environment in which its equipment will be operated. It is the responsibility of the owner and the operator to remain alert to any hazards posed by the function of this equipment. If you are ever uncertain about a particular task or the proper method of operating this equipment, ask your supervisor.

This manual contains a number of precautions to follow to help promote safe use of this equipment.

Throughout the manual you will see additional warnings to help alert you to potential hazards.

### Warning affection your personal safety indicated by:



### Warning affect or possible damage to the equipment and property are

indicated by: **CAUTION**

If any warning labels or this manual are misplaced, damaged, or illegible, or if you require additional copies, please contact your nearest representative or vendor directly for these items at no charge.

Please remember that this manual or the warning labels do not replace the need to be alert, to properly train and supervise operators, and to use sense when using this equipment.

Please remember that this manual or the warning labels do not replace the need to be alert, to properly train and supervise operators, and to use sense when using this equipment.

## Unpacking & Installation

**⚠ WARNING** TO AVOID SERIOUS PERSONAL INJURY AND PROPERTY DAMAGE:

- ALWAYS install equipment in a work area with adequate light and space.
- ONLY operate on a solid, level, nonskid surface that is nonflammable and away from sinks and water hazards
- NEVER bypass, alter or modify this equipment in any way from its original condition. Doing so may create hazards and will void warranty.

### **GAS and GAS PRESSURE**

#### **CAUTION**

This unit is factory supplied in Nature Gas. This unit can be converted to L. P gas by a licensed and certified gas technician. Documentation may be necessary for warranty issues. Failure to comply with this instruction, will void warranty.

***See the included L.P. conversion kit for gas conversion parts and instructions.***

#### **⚠ WARNING**

**Unit installation must conform with the National Fuel Gas Code, ANSI Z223.1/NFPA 54, the National Gas installation Code, CSA-B149.1, or the Propane installation Code, CSA-B149.2 as applicable and in accordance with local codes.**

#### **⚠ WARNING**

The appliance and its individual shutoff valve (to be supplied by user) must be disconnected from the gas supply piping system during any pressure testing of that system at test pressures in excess of 1/2 psi(3.45kPa)

These models are designed, built, and sold for commercial use only.

Instructions must be posted in a prominent location. ALL safety precautions must be taken in the event the user smells gas. Safety information can be obtained from your local gas supplier.

### **UNPACKING**

Unpack the griddle immediately after receipt. Remove the gas griddle from the crate; remove all packaging on and surrounding the unit and be certain to remove all protective plastics and residues from all surfaces. Make sure that all parts provided including the L.P. gas conversion kit are located.

If the machine is found to be damaged, save the packaging material and contact the carrier within fifteen (15) days of delivery. Immediately contact Dukers or your local dealer of the equipment. You have no recourse for damage after fifteen (15) days.

## Unpacking & Installation

### INSTALLATION

1. Read this manual thoroughly before installation and operation. DO NOT proceed with installation and operation if you have any questions or do not understand anything in this manual. Contact your local representative.
2. Select a location for the griddle that has a level, solid, nonskid surface that is nonflammable and away from water hazards or sinks, and is in a well-lighted work area away from children and visitors.
3. Equipment must be installed under proper ventilation as required per local code.
4. NOTICE: Local codes regarding installation and ventilation vary greatly by area. The National Fire Protection Association, Inc. states in its NFPA 96 latest edition (see NFPA page at the beginning of this manual) that local codes are "authority having jurisdiction" when it comes to requirements for installation of equipment. Therefore, installation should comply with all local codes.
5. This appliance is equipped for Natural gas, for conversion to LP gas please see another conversion kits instruction.
6. Screw legs into the permanently fastened nuts on the four corners of the unit and tighten by hand. Legs must be installed to adequately provide proper ventilation to the unit.
7. Level unit by adjusting the four feet and tighten securely. The adjustable feet have an adjustment of one inch for lineup with other countertop lines. Do not slide unit with legs mounted, lift if necessary to move unit.
8. The supplied gas pressure regulator is factory set at a 4" Natural gas W.C. or 10" for L.P.
9. THESE UNIT ARE SUITABLE FOR INSTALLATION ON NO-COMBUSTIBLE SURFACES ONLY.  
Noncombustible clearances: 0" side (0 mm) 6" rear (152 mm) 4" floor (102 mm)
10. Do not obstruct the flow of combustion and ventilation air, under the unit by the legs or behind the unit by the flue. Do not place objects between the bottom of the unit and the counter top.
11. There must be adequate clearance for removal of the front panel. All major parts except the burners are removable thru the front if the gas line is disconnected.
12. It may be necessary to adjust the balance of gas volume and air supply to each burner. This must be done by an authorized service technician.
13. Pipe threading compound must be resistant to the action of liquefied petroleum gases.

 **WARNING DO NOT use an open flame to check for leaks. Check all gas piping for leaks with a soap and water solution before operating unit.**

**COMMISSIONING:**

Commissioning of your new griddle is of the utmost importance. Commissioning is the thorough and methodical testing of the equipment, sub systems, and systems to ensure that the final product functions properly and safely at the work site. By identifying any potential problems (i.e.: equipment location, ventilation, local fire/electrical codes, installation, operator training and certification) prior to equipment being placed into service, costly outages and potential damages may be avoided.

## Warnings and Safeguards for Operation

### WARNING

#### TO AVOID SERIOUS PERSONAL INJURY AND PROPERTY DAMAGE

 **WARNING** For your safety, do not store or use gasoline or other flammable vapors or liquids in the vicinity of this or any other appliances. Keep the area free and clear of combustibles. (See ANSI Z83.14B.1991).

 **WARNING** Improper installation, adjustment, alteration, service or maintenance of this equipment can cause property damage, personal injury, or death and voids warranty. Read the installation operating and maintenance instructions thoroughly before installing, or operating this equipment.

 **WARNING** Instructions must be posted in a prominent location. All safety precautions must be taken in the event the user smells gas. If you smell gas, immediately shut off the main gas valve, extinguish all heat and flames, and call 911. Safety information can be obtained from your local gas supplier.

#### IMPORTANT SAFEGUARDS & SAFETY INSTRUCTIONS

**CAUTION** when using gas cooking equipment, basic safety precautions should always be followed, including the following:

The griddle burners, cooking grates and outside surfaces may become HOT after use. Use caution when touching the unit.

- Never directly touch the burners or cooking grates while the griddle is on.
- Always turn off the unit when not in use, servicing or adjusting any parts or attachments, and before cleaning.
- Do not operate any equipment with a damaged or leaking gas line, ignitor or valves or if the unit is dropped or damaged in any manner. Call for service.
- The use of attachments not recommended or sold by the manufacturer may cause fire, injury or even death.
- Do not use outdoors.
- Do not use this equipment for any use other than the use intended by the manufacturer.
- Never use the equipment for any use as a heating source.
- The griddle does not contain any user-serviceable parts. Dealers of recommended qualified technicians should carry out repairs. Do not remove any components or service panels on this product.
- Never bypass, alter, modify or attach any unauthorized parts to this equipment.

Doing so may create hazards and will void warranty

- Supplier takes every care to ensure that all products are safe. Steal cutting procedures used to however, we insist the operator take care when in contact with this piece of equipment.
- Always keep hands, hair and clothing away from heating source.
- Allow the griddle to cool down after use and before dismantling for cleaning; the unit will be too hot handle immediately after use.

## Operating Instructions

### **Operating the griddle-pilot lighting instructions**

Before operating griddle, it should be checked to see that it is sitting level. Adjust the feet to level the griddle. Be sure the catch tray has been properly placed.

The pilot lights on the appliance have been set at factory. Each burner has a pilot light.

1. Make sure all knobs are in the "OFF" position.
2. The main gas valve should be "CLOSED/OFF" for five minutes prior to lighting pilots to clear any exiting gas. (Main gas valve is supplied by others.)
3. Turn "ON/OPEN" the main gas valve to the unit.
4. Light and hold an ignition source (match) at the pilots. When the flame is established, remove the ignition source. Repeat this step for each burner as each burner has its own individual pilot. The pilot can be reached through the holes in the front of the unit.
5. Adjust the pilot valve, make sure the pilot flame at 1/2 inch height.
6. Turn each burner knob "ON". If the burners do not ignite promptly, turn the Knobs "OFF", From the opening in the front panel, use a screwdriver and turn the pilot valve screw counterclockwise which will increase the flame height and repeat step4.

The pilot flame should be as small as possible but large enough to guarantee reliable ignition of the burners when the knobs are turned to "ON". The holes located in the front panel are pilot valve adjustments. Use a screwdriver to turn the valve to adjust the flame height to your desired level.

### **Igniting the burner**

To ignite the burner, turn knob to the "ON" position. Then back off to the desired flame level. The range of adjustment is virtually infinite between "ON" and "OFF"

The space between the legs at the bottom admits combustion air. DO NOT BLCOCK THIS SPACE.

All burners are lit from constantly burning pilots. Turning the valve to the desired flame height is all that is required to put the unit in service.



Do not permit fans to blow directly at the unit. Wherever possible, avoid open windows next to the unit's sides or back. Avoid wall type fans which create air cross-currents within a room.

It is also necessary that sufficient air should be allowed to enter the room to compensate for the amount of air, removed by any ventilating system. Otherwise, a subnormal atmospheric pressure will occur, affecting operation and causing undesirable working conditions.

A properly designed and installed hood will act as the heart of the ventilating system for the room of area in which the unit is installed, and will leave the unit independent of changing draft conditions.

NOTE: it may be necessary to adjust the balance of gas, volume and air supply to each burner. This must be done by a authorized technician.

### **Seasoning the griddle**

Heat to low temperature (300~350°F /150~180°C) and pour small amount of cooking oil to the griddle plate(about one ounce(30cc)) per square foot of surface). Spread the oil over the entire griddle surface with a cloth to create a thin film. Wipe off any excess oil excess oil with a cloth. Repeat this procedure 2 to 3 times until the griddle ha a slick, mirror-like surface.

### **Operating the griddle**

Turn the burners on about 15-20 minutes before cooking for preheating. Set the knobs to the desired flame height, Each valve controls the gas flow to the burner to bring that area of the unit up to the set temperature.

If different temperature settings are to be used, adjoining areas should be set at progressively higher temperatures using the lowest temperatures on the outside burners. Uniform and systematic approaches to the loading of the unit produce the most consistent product results.

### **Shutdown the burner**

To turn "OFF" the appliance completely, turn the gas control knob completely clockwise to "O" position, the pilot burner will extinguish.

## Cleaning Instructions

### CAUTION

DO NOT use any abrasive or flammable cleaning fluids;

DO NOT hose down immerse or pressures wash any part of the griddle, excluding the catch tray.

NEVER use a scrubber pad, steel wool or abrasive material, or cleaners containing chlorine, iodine and ammonia or bromine chemicals as these will deteriorate the stainless steel and shorten the life of the unit.

**⚠ IF CLEANING THE BURNER OF THE GRIDDLE, THE MAIN GAS VALVE MUST BE SWITCHED TO THE CLOSED POSITION. AFTER CLEANING, THE GAS LINE CAN BE SWITCHED BACK TO THE OPEN POSITION. PLEASE FOLLOW THE LIGHTING INSTRUCTIONS IN THIS MANUAL TO RELIGHT THE GRIDDLE'S PILOT LIGHTS.**

### **RECOMMENDED CLEANING**

It takes very little time and effort to keep the griddle attractive and performing at the top efficiency. Please follow the cleaning steps below.

PART	REQUIRED ACTION	FREQUENCY
Body	Use a clean cloth and a non-abrasive cleaner to clean the stainless steel body of the griddle. Wipe the polished areas with a soft cloth	Daily
Back and Side Splashes	Wipe the polished areas with a soft cloth. Thoroughly clean. Wipe with clean, warm, mildly, soapy water then wipe splashes with damp cloth	Daily
Controls	Unit should be turned off when not in use. It is recommended that the unit be disconnected from the gas supply by closing the main gas valve. Use a clean cloth to wipe any down controls and/or knobs	Daily
Griddle Plate	Clean surface with wire brush or metal spatula. Clean the griddle surface thoroughly. If necessary, use a griddle stone wire brush or steel wool on the surface. Rub with the grain of the metal while the griddle is still warm. A mild soap may be used on the plate surface to help clean it. Remove all soap and debris thorough with a clean, damp cloth. The plate should then be covered with a thin film of oil to prevent rusting. Clean stainless surfaces with a damp cloth and polish with a soft dry cloth. To remove discoloration, use a nonabrasive cleaner. After each weekly cleaning, the griddle must be	After each use Weekly

	<p>seasoned again. If the griddle usage is very high, the weekly cleaning procedures may be done more often than once a week.</p> <p>Do not put ice on the griddle plate as this may damage the plate</p>	
Catch Tray	<p>Once the unit has cooled, remove the catch tray and discard the wastes, debris and crumbs. CAUTION: if the catch tray is permitted to fill too high, debris is likely to accumulate under the unit. The catch tray/drawer is removed by pulling forward. USE CAUTION WHEN ROMOVING!</p>	Per use or at least Daily
Regulator	<p>Make sure the vent opening is open and not blocked in any way. Failure to do so will cause variations in pressure. Your unit will not function as well and it could shorten the life of the product</p>	Monthly

## Troubleshooting

ISSUE	CAUSE	SOLUTION
Griddle not lighting	Main gas line is closed	Open valve
	Pilot light is not lit	Ignite pilot light
	Cause unknown	Call for service
Flame is too high or too low	Adjustment knob is turned up or down	Adjust flame with control knob
Pilot light not staying lit	Flame is too low	Adjust pilot light flame height
	Pilot tube clogged	Replace pilot tube. Call for service
Strong smell of gas in cooking area	Main gas line leak	Turn off main gas valve. DO NOT LIGHT FLAME, ignite anything, or turn/switch on anything electrical, Call fire department if needed and call for service
Cooking surface is heating up slowly	Carton build up	Ensure that the burners are kept clean and free from carbon build up/debris
Gas type of Unit needs to be converted		Contact an authorized servicer. Do not attempt conversion on your own

**IF problems persist and the assigned solution does not remedy the issue, please call service department or your local service company.**

## Conversion Kit Instructions for the Gas Griddle

### IMPORTANT SAFETY NOTICE

These conversion instructions are for conversion of the griddle. The instructions provide in this kit are for the conversion of Natural Gas to LP gas and refer to the conversion of the unit and kit provided. An improperly converted this unit, can result in serious injury, property damage or death and will void warranty.

### Griddle Conversion Kit Instructions

**⚠ WARNING** Do not attempt gas conversion by yourself. Gas conversion of your unit is to be made by a certified/licensed technician.

### CONVERSION

Instructions are for conversion from Natural Gas to Propane (L.P.) on all models. The conversion should be done before connecting the unit to the gas supply. Units are shipped from the factory equipped for use on natural gas.

Parts necessary for L.P. (propane) are provided with the unit. Turn off the main gas supply before doing any maintenance.

1. Remove the knobs and front panel



2. Unscrew bolts and pilot valve, then remove manifold

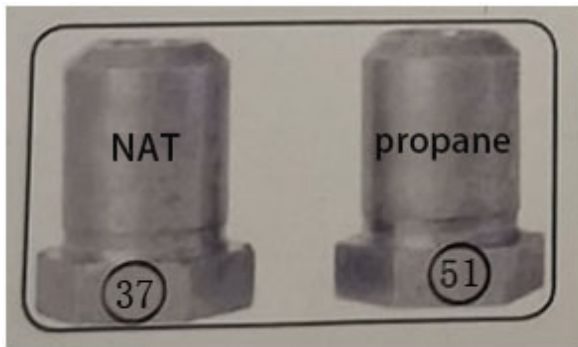

**3. Replace the front panel and knobs****4. Before installing the included convertible regulator, unscrew the octagon cap. You can read (NAT) on the plastic insert attached to the head of the cap; flip it over and snap back in place.**

**Pictured is the plastic insert. Pull off insert from the octagon cap head and reverse the plastic insert position so that the L.P. position is attached to the octagon cap head.**

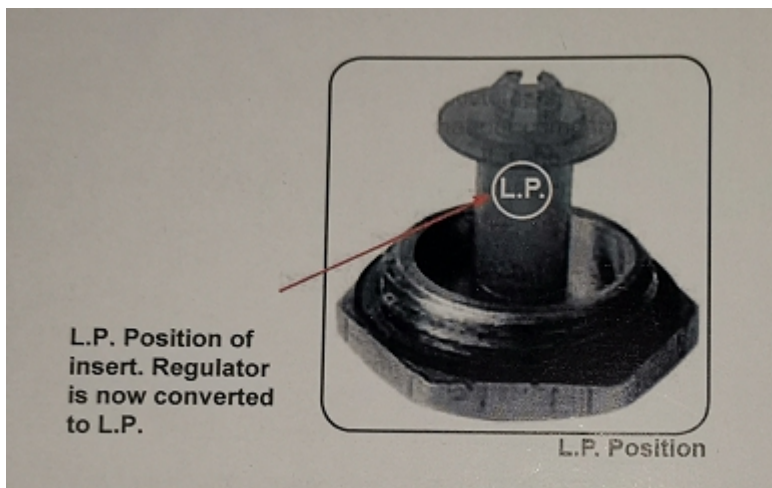
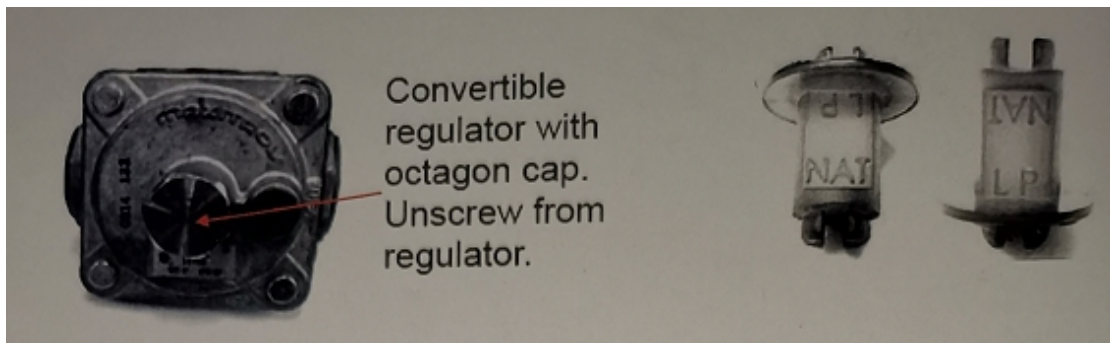
**5. Continue with installation**

## Limited Warranty

DUKERS warrants to the original purchaser of new equipment that said equipment, when installed in accordance with our instructions within North America and subjected to normal use, is free from defects in material or workmanship for a period of 1 year. The labor warranty is one year from original installation or 18 months from actual factory shipment date whichever date occurs first. Warranty includes onsite service calls within 60 miles of an authorized service company. End user is responsible for all extra travel and mileage at prevailing rates

**THIS WARRANTY IS IN LIEU OF ALL OTHER WARRANTIES, WHETHER EXPRESSED OR IMPLIED. DUKERS EXPRESSLY DISCLAIMS ANY IMPLIED WARRANTY OF MERCHANTABILITY OR EXPRESSED OR IMPLIED WARRANTY OF FITNESS FOR A PARTICULAR PURPOSE.**

Dukers's obligation and liability under this warranty is expressly limited to repairing and replacing equipment which proves to be defective in material or workmanship within the applicable warranty period.

All repairs pursuant to this Warranty will be performed by an Authorized Designated DUKERS Service Location during normal working hours.

This warranty does not cover services performed at overtime or premium labor rates. End user is responsible for the difference between normal service rates and premium service rates.

**IN NO EVENT SHALL DUKERS BE LIABLE FOR INCIDENTAL OR CONSEQUENTIAL DAMAGES TO BUYER OR ANY THIRD PARTY INCLUDING, WITHOUT LIMITATION, LOSS OF PROPERTY, PERSONAL INJURY, LOSS OF BUSINESS OR PROFITS OR OTHER ECONOMIC LOSSES, OR STATUTORY OR EXEMPLARY DAMAGES WHETHER IN NEGLIGENCE, WARRANTY, STRICT LIABILITY, OR OTHERWISE**

This warranty is given only to the first purchaser from a retail dealer. No warranty is given to subsequent transferees.

Warranty does not cover product failures caused by: failure to maintain, neglect, abuse, damage due to excess water, fire, normal wear, improper set up and use. Periodic maintenance is not covered This warranty is not in force until such time as a properly completed and signed installation/warranty registration or an online registration form has been received by DUKERS within 30 days from the date of installation.

Proof of purchase is required to extend warranty more than 1 year from date of shipment from the factory.

**THE FOREGOING WARRANTY PROVISIONS ARE A COMPLETE AND EXCLUSIVE STATEMENT BETWEEN THE BUYER AND SELLER. DUKERS NEITHER ASSUMES NOR AUTHORIZES ANY PERSONS TO ASSUME FOR IT ANY OTHER OBLIGATION OR LIABILITY IN CONNECTION WITH SAID EQUIPMENT**

**Example of items not covered under warranty, but not limited to just these items**

- 1 Acts of God, fire, water damage, burglary, accident, theft**
- 2 Freight damage**
- 3 Improper installation or alteration of equipment**
- 4 Use of generic or after-market parts**
- 5 Repairs made by anyone other than a DUKERS designated servicer**
- 6 Lubrication.**
- 7 Expendable wear parts, adjustable feet, blown fuses, lamps, etc.**
- 8 Cleaning of equipment**
- 9 Misuse or abuse**

**DUKERS APPLIANCE CO., USA LTD  
TOLL FREE: 1-800-931-8628 | FAX: 562-801-3026  
INFO@DUKERSUSA.COM | WARRANTY@DUKERSUSA.COM  
CORPORATE OFFICE: 2488 PECK ROAD, CITY OF INDUSTRY, CA 90601  
WWW.DUKERSUSA.COM**