



# CHEST FREEZER

WD-700Y



## TECHNICAL SPECIFICATIONS

Voltage/Frequency	110V/60Hz
Refrigerant	R290
Type of Defrost	Automatic
Interior Finish	White
Interior Finish	White
Temperature Range °F	-8 ~ 0 °F
Compressor Power (HP)	1/5
Nema Config.	NEMA5-15P

## PRODUCT FEATURES

- Equipped with Locking Lids.
- Fan assisted condenser & copper evaporator.
- Temperatures in the cabinet range from -8 to 0 degrees Fahrenheit.
- R290 Natural Refrigerant promotes faster cool down and efficient energy consumption.
- Digital controller and LED temperature display.
- Interior LED light with switch.
- Low-E treated curved glass sliding lids to enhance better cooling.
- Anti-fogging tempered glass helps ensure a crystal clear view of the interior.
- Basket included.
- Bumper bars protection in the front of the unit to prevent impacts and support excessive usage.
- 4" casters with lock for easy mobility.

## HIGH QUALITY STAINLESS STEEL & ROBUST DESIGN



Los Angeles | San Francisco | Dallas  
Houston | Florida | Chicago | New Jersey

1-800-931-8628

@ info@dukersusa.com

www.DukersUSA.com

# DETAILS & SPECIFICATIONS

## CHEST FREEZER WD-700Y

Front View

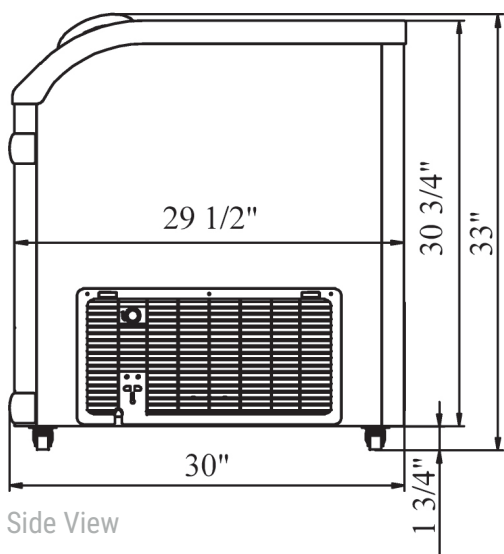
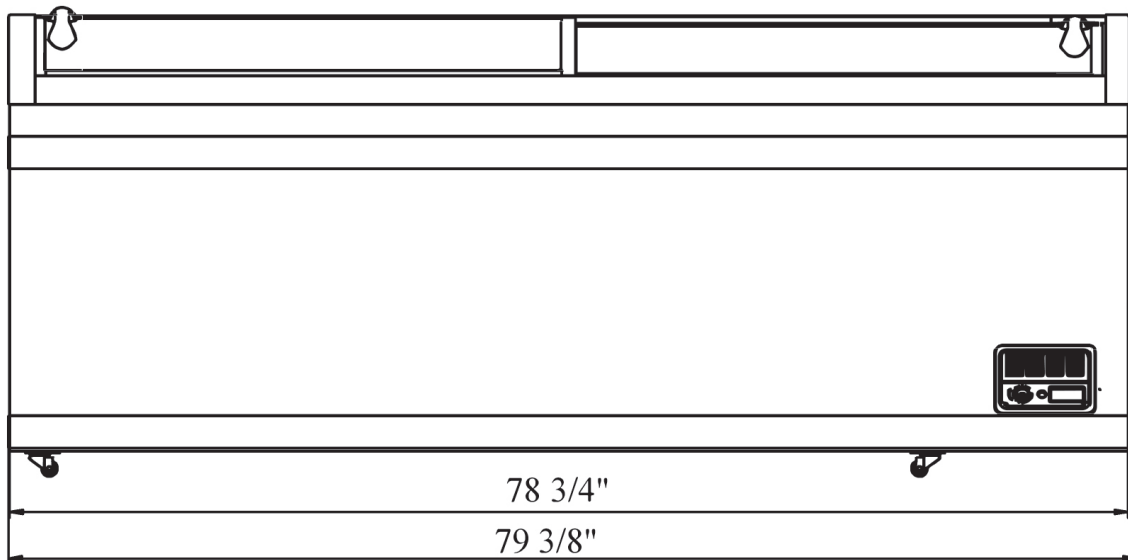

Side View

### MODEL WD-700Y

Basket Size	11 x 21.5 x 6
Rated Voltage	110V
Rated Frequency	60Hz
Total Input Power	380W
Total Current	3.8A
Total Capacity	24.72 cu ft
Climatic Category	4-5
Protection Type	I
Design Pressure High Side	300 PSIG
Design Pressure Low Side	150 PSIG
Insulation Blowing Gas	C-Pentane
Refrigerant	R290

MODEL	EXTERNAL DIMENSION WXDXH (INCHES)	PACKAGING DIMENSION WXDXH (INCHES)	PRODUCT NET WEIGHT	# OF BASKETS	40HQ CONTAINER CERT.
WD-700Y	79 3/4 x 29 5/8 x 33 1/8	81 3/4 x 31 5/8 x 34 5/8	333 lbs	6	41



Los Angeles | San Francisco | Dallas  
Houston | Florida | Chicago | New Jersey

1-800-931-8628

@ info@dukersusa.com

www.DukersUSA.com